



SN.

Dr. Jekyll & Mr. Hyde®

THE EXHAUST

MANUAL : HARLEY-DAVIDSON® | EASYMOUNT | BLACKBOX



NRS, V-Rod 2012 ->, Streetrod

1

NRS, V-Rod 2012 up, Streetrod Easymount Blackbox

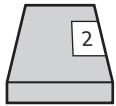
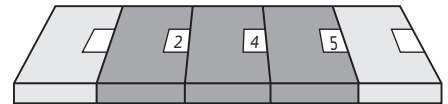

Mode Switch for Blackbox

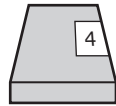
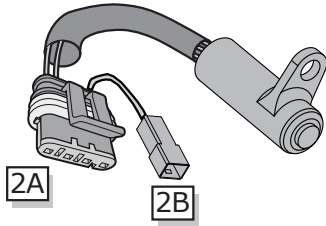

Blackbox

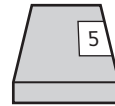
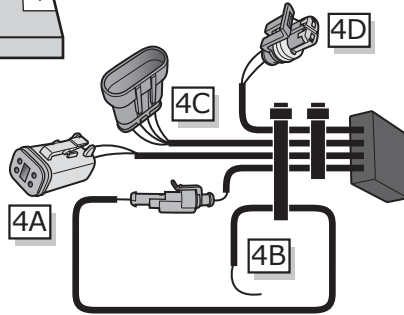

Y Cable

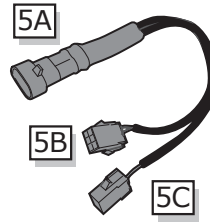

Exhaust/cable/servo system

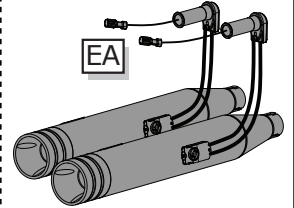

2

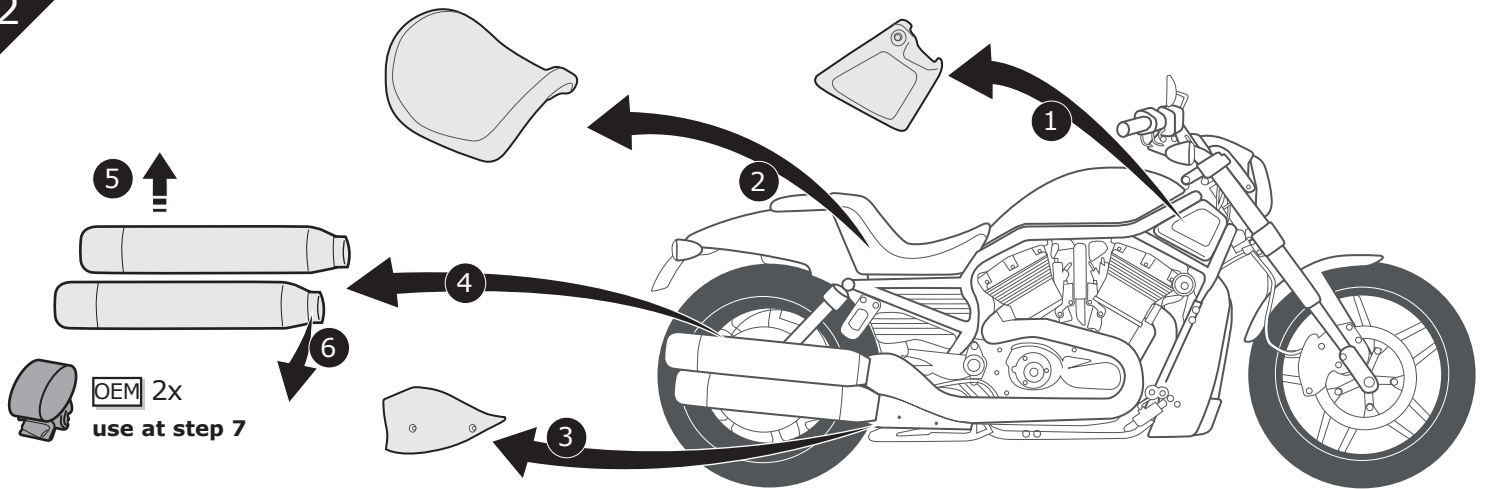

5 ↑

OEM 2x
use at step 7

3

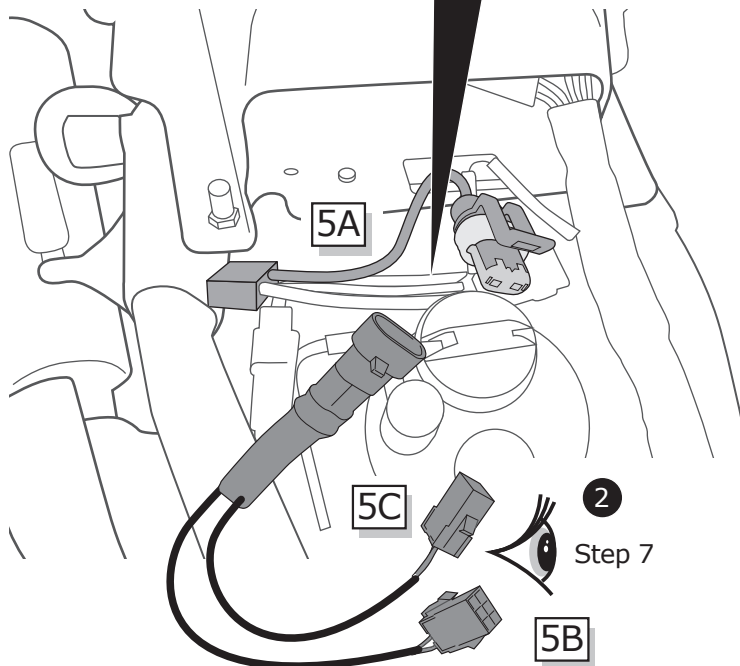
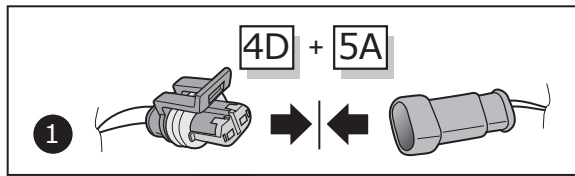
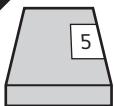

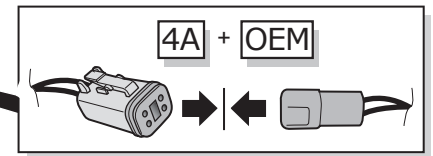
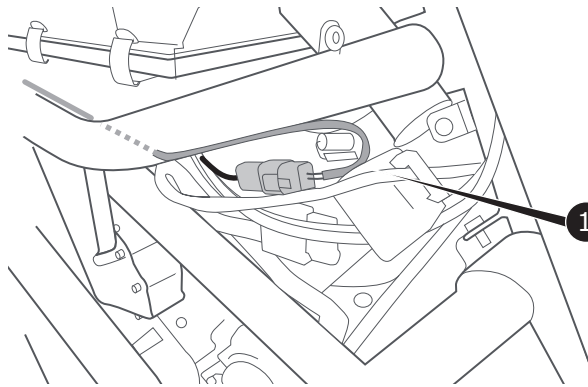
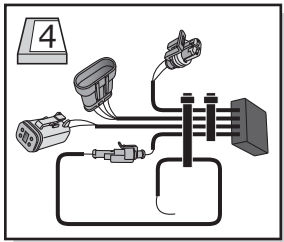
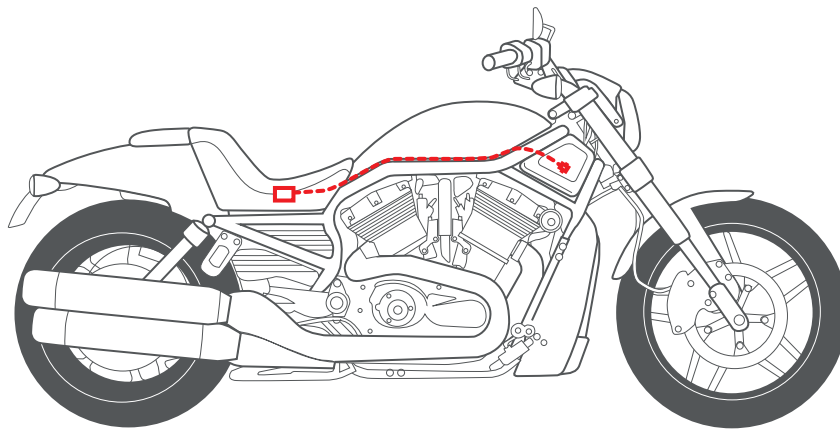

Speed signal

1
 (NL) Zwart-Blauw
 (DE) Schwarz-Blau
 (GB) Black-Blue

2
 (NL) Zwart-Blauw
 (DE) Schwarz-Blau
 (GB) Black-Blue

3
 (NL) Groen
 (DE) Grün
 (GB) Green

4B

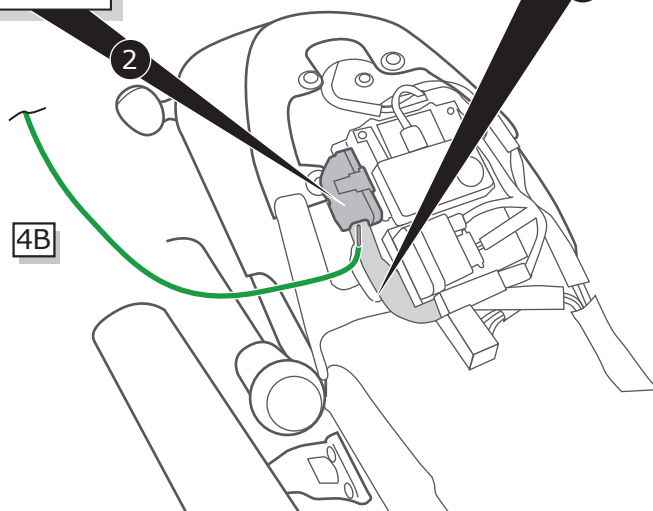
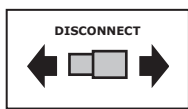

5

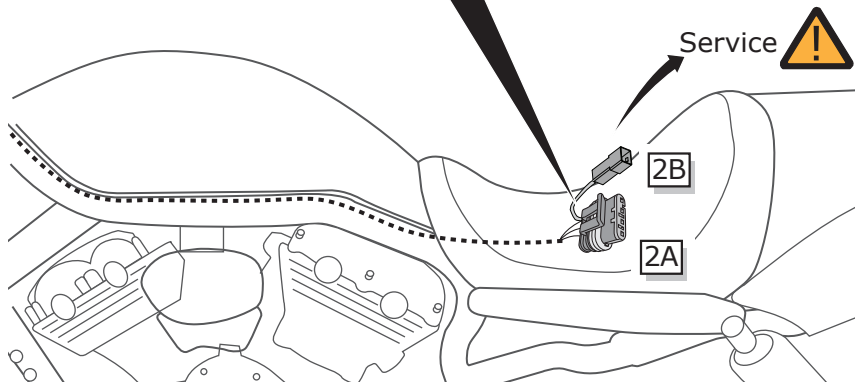
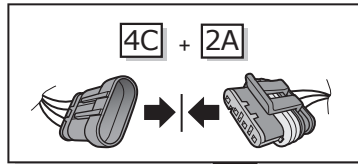
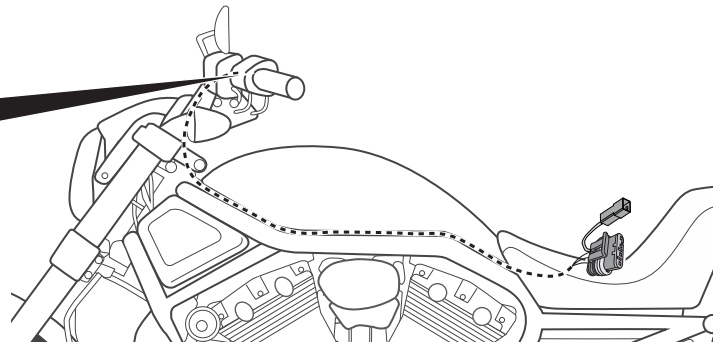
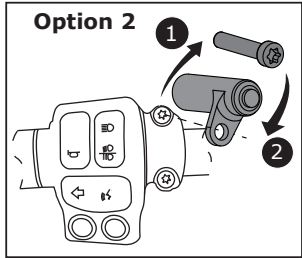
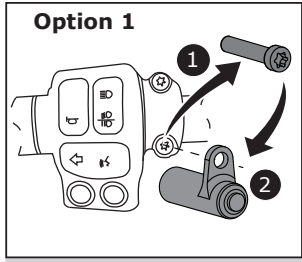
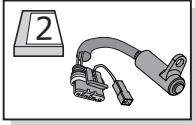

6

Items needed at step 7

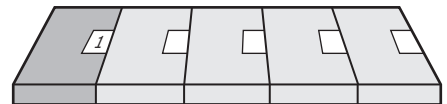

Assembly Kit

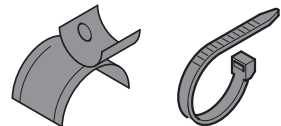

CA
2x

TW
16x

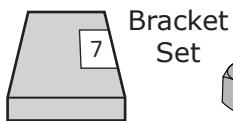

Bracket Set



N1
6x

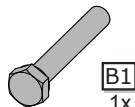

B1
1x

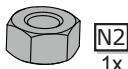

N2
1x



W1
2x



Sw1
1x

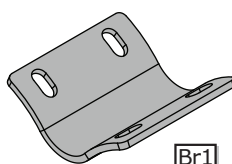

Br1
1x

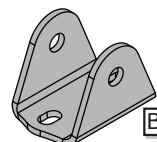

Br2
1x

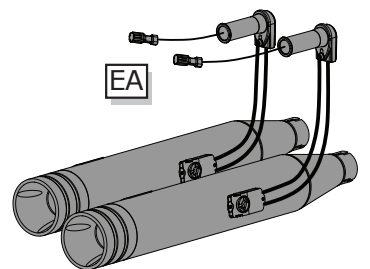

EA

7

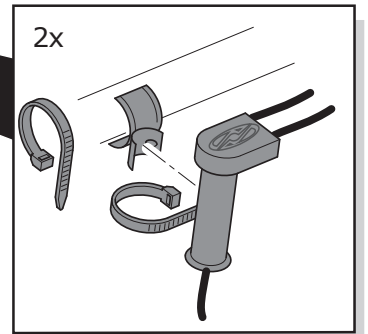
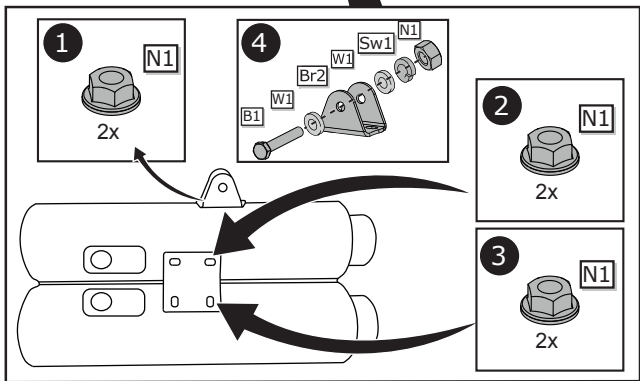
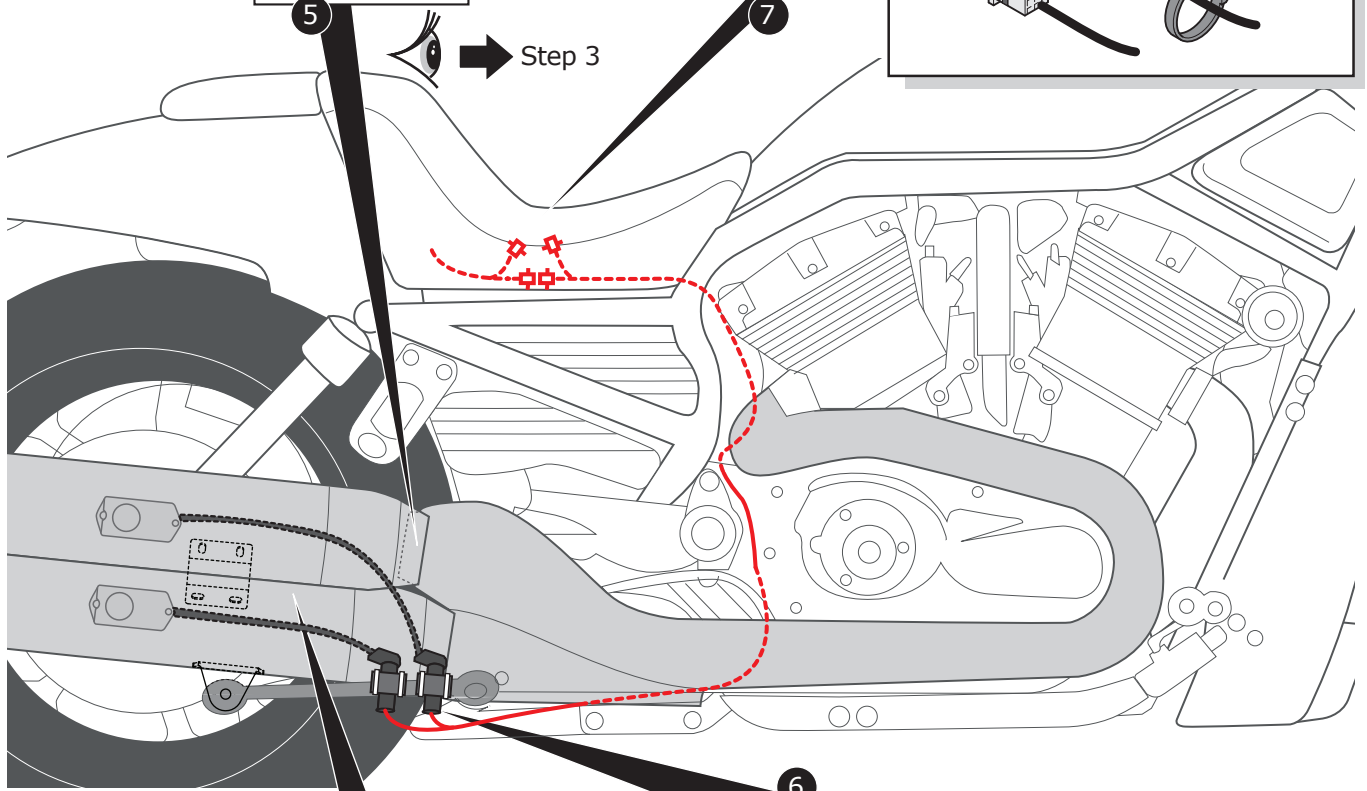
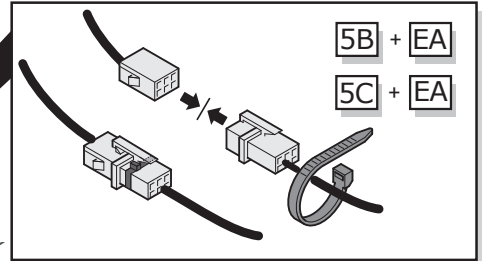
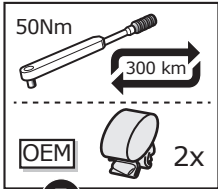

8

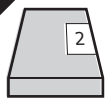

1
Complete System Check!

