



SN.

Dr. Jekyll & Mr. Hyde®

THE EXHAUST

MANUAL : HARLEY-DAVIDSON® | EASYMOUNT | BLACKBOX



VRSC Muscle

1

VRSC Muscle Easymount Blackbox

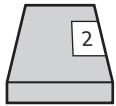
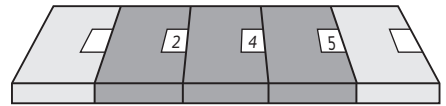

Mode Switch
for Blackbox

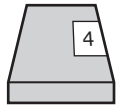
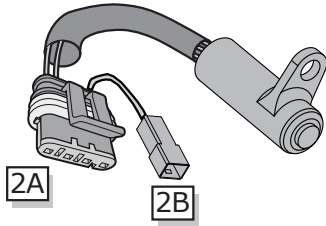

Blackbox

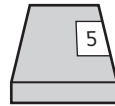
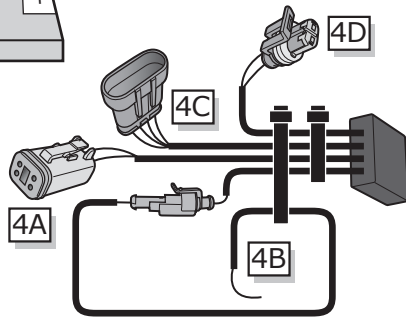

Y Cable

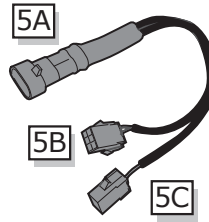

Exhaust/cable/
servo system

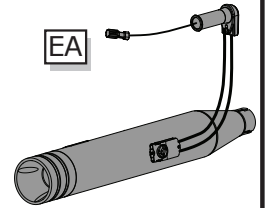

2

5

Left and Right

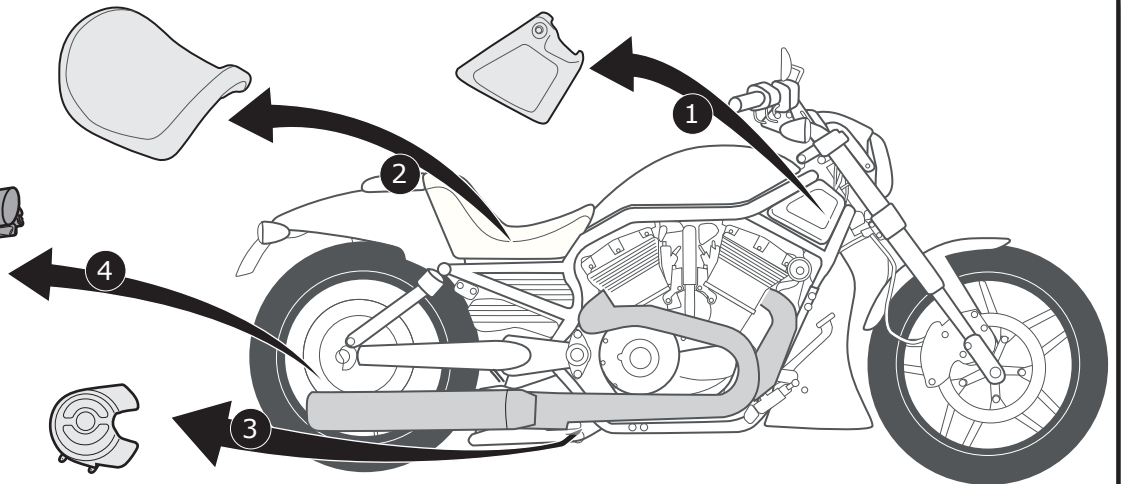
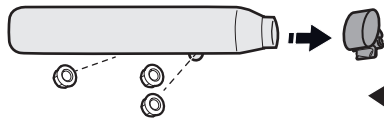

3

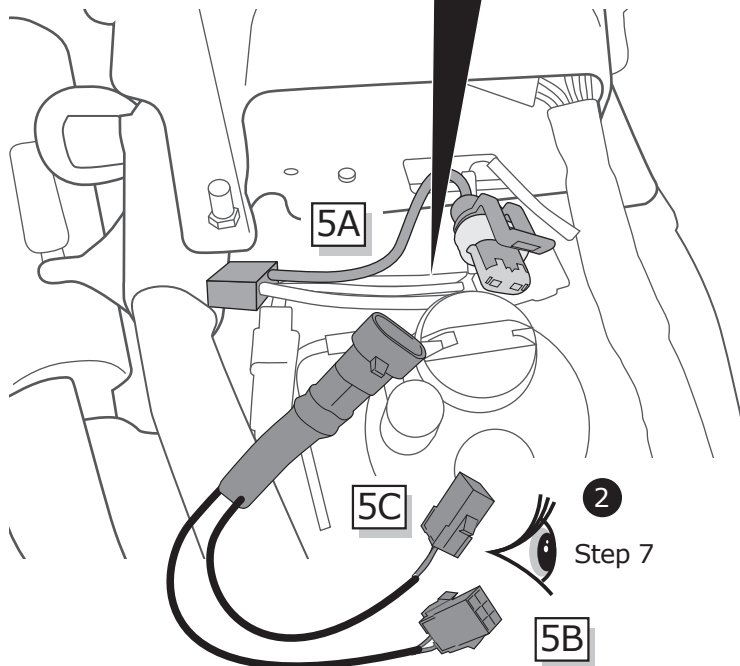
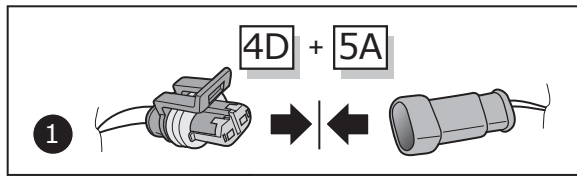
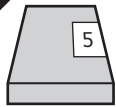

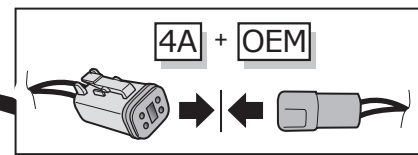
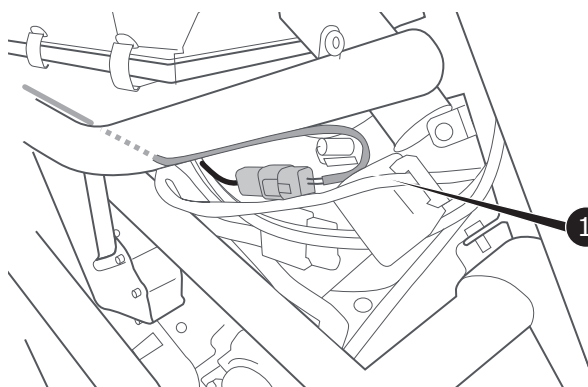
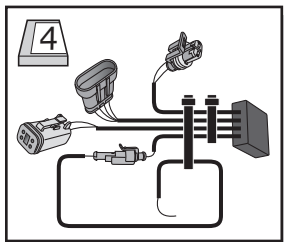
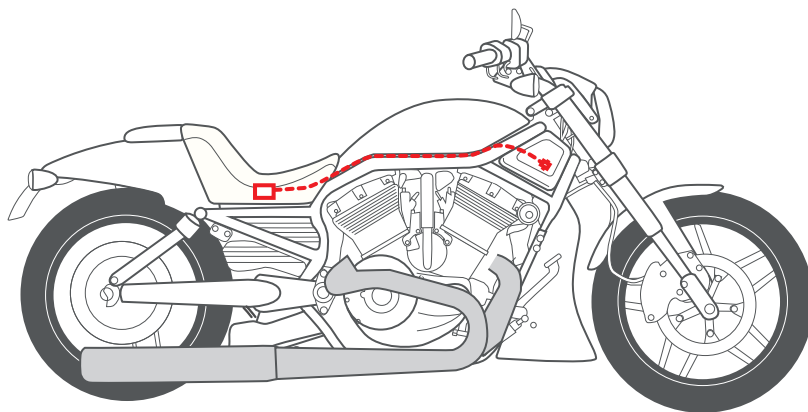

Speed signal

1 **(NL) Zwart-Blauw**
(DE) Schwarz-Blau
(GB) Black-Blue

2 **(NL) Zwart-Blauw**
(DE) Schwarz-Blau
(GB) Black-Blue

3 **(NL) Groen**
(DE) Grün
(GB) Green

4B

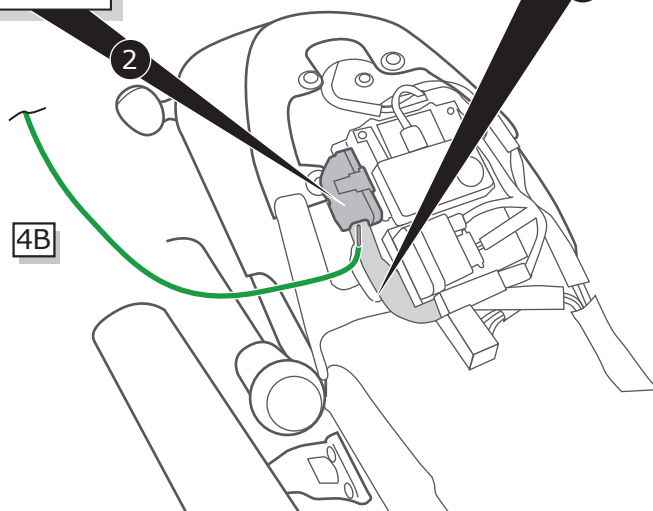
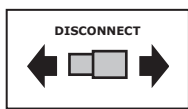

5

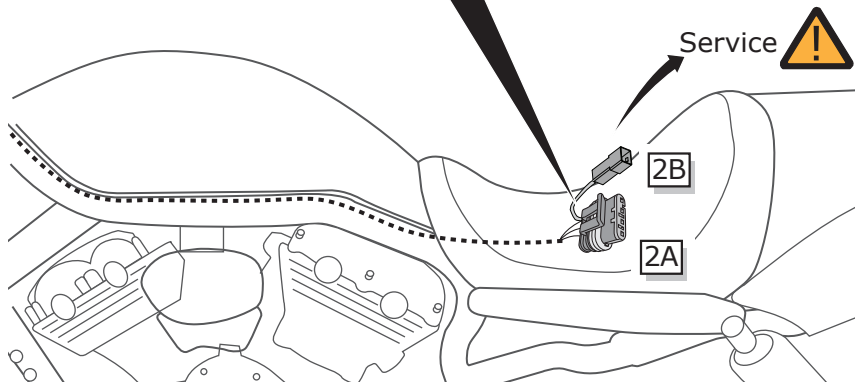
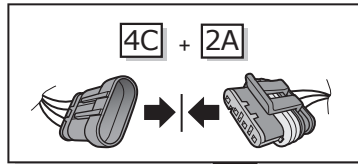
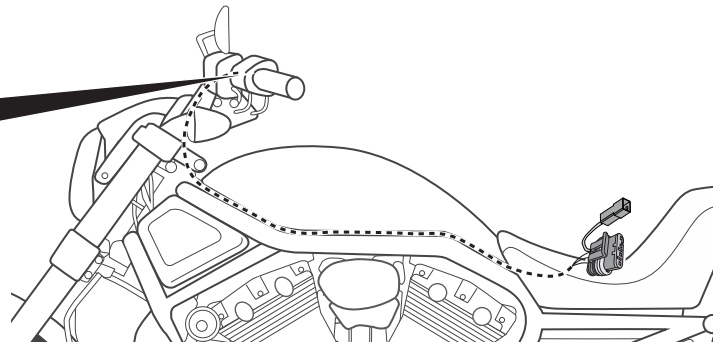
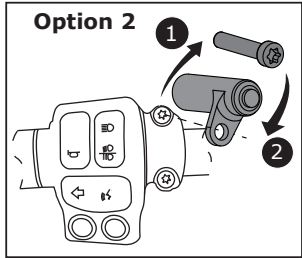
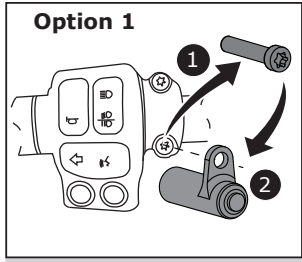
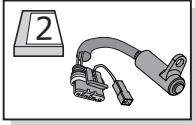

6

Items needed at step 7

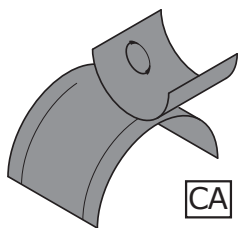
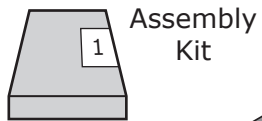
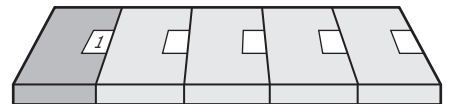

CA
2x

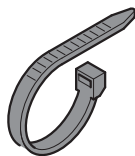

TW
16x

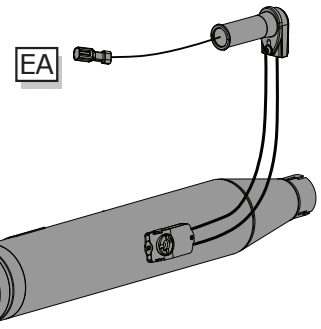

7

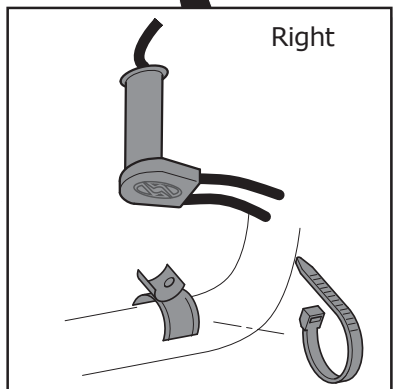
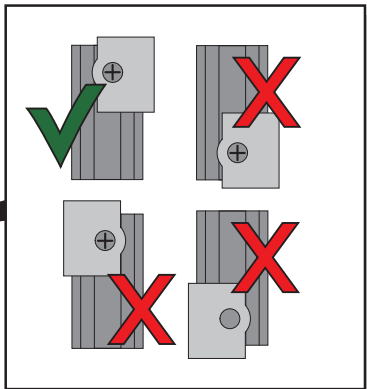
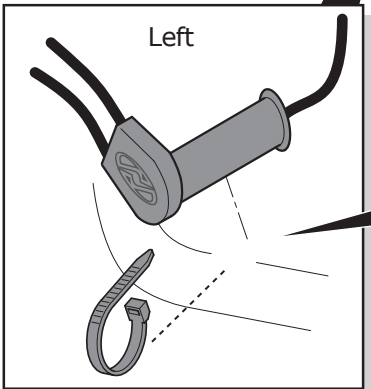
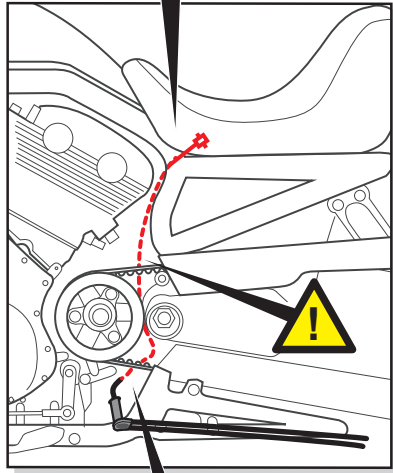
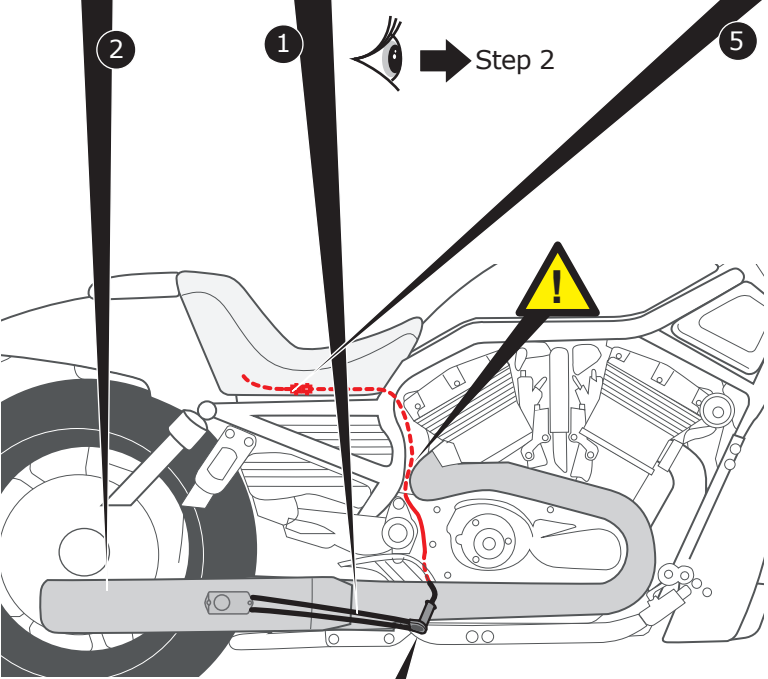
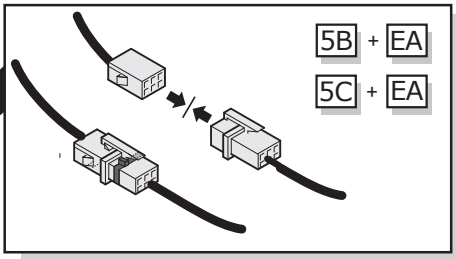
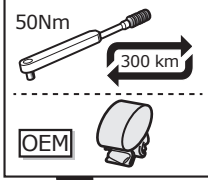
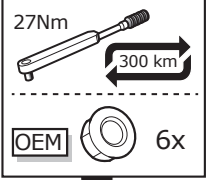

8

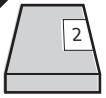

1

Complete System Check!

