



SN.

Dr. Jekyll & Mr. Hyde[®]

THE EXHAUST

MANUAL : HARLEY-DAVIDSON[®] | EASYMOUNT | SMARTBOX 2

NEW IN THIS MANUAL:

- SMARTBOX 2
- EXHAUST MOUNTING
- J&H GASKETS
- SERVO POSITIONS

Now also for
35 kW available



Sportster
2017->

1

Sportster 2017-> Easymount Smartbox 2

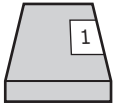
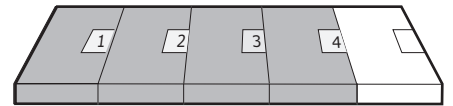

Assembly Kit

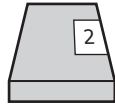
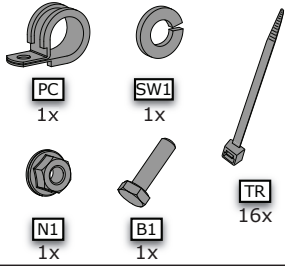

Smartbox 2

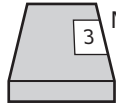
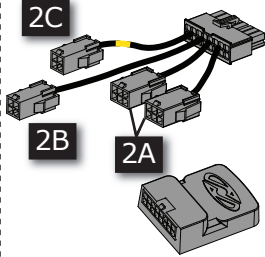

Mode Switch for Smartbox

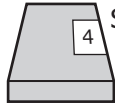
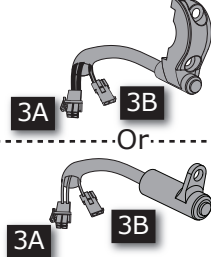

Smartbox Control Cable

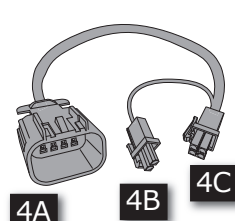

Exhaust/Cable/Servo System

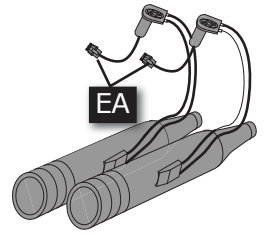

2

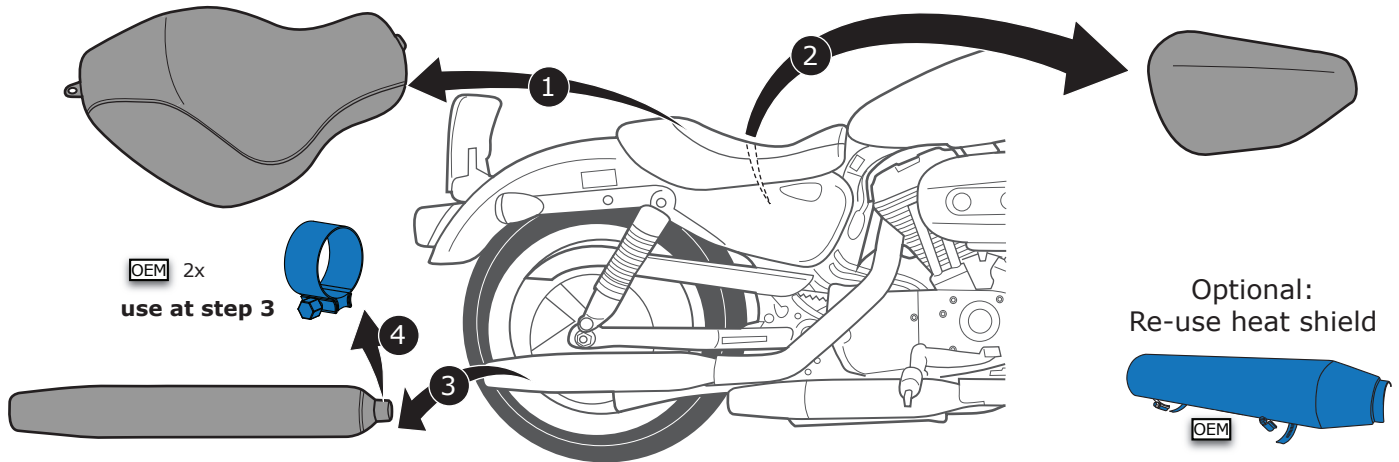

3

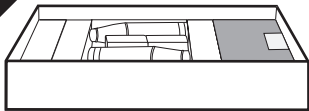

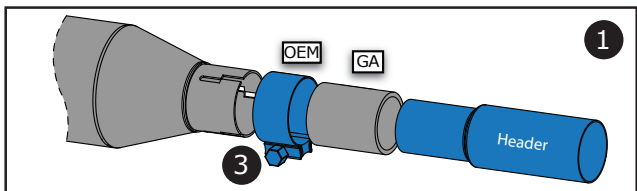
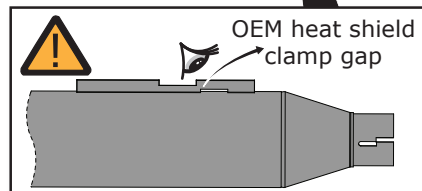
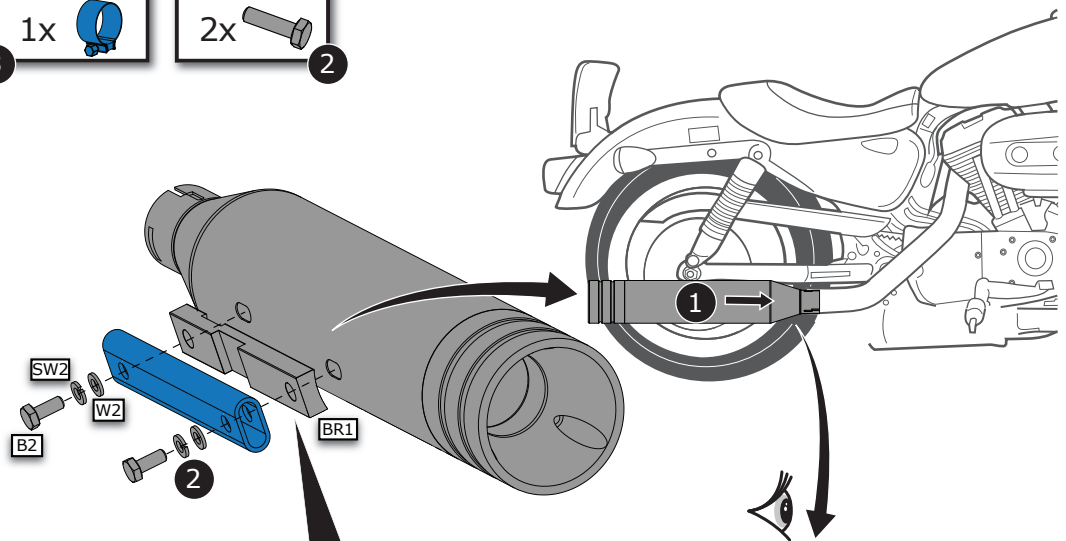
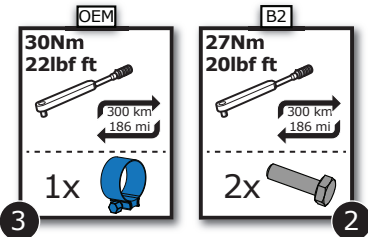
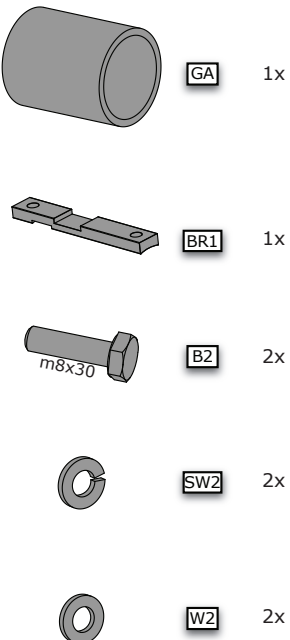

Items required



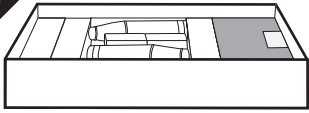

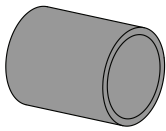
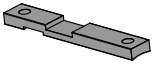
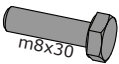

4



Items required

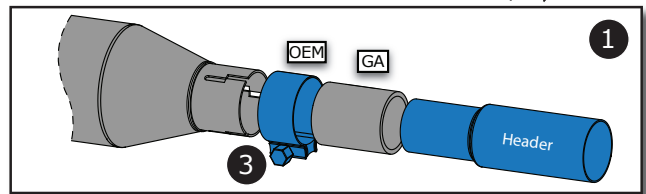
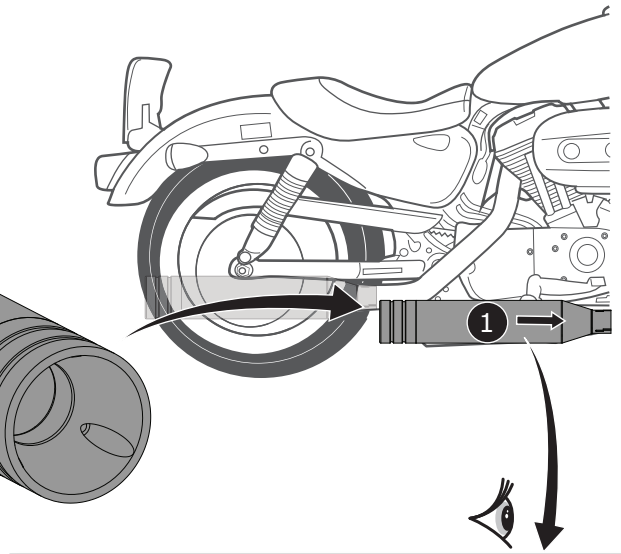
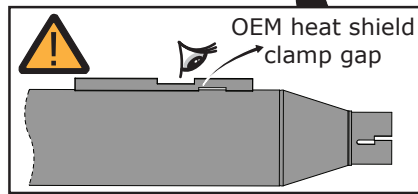
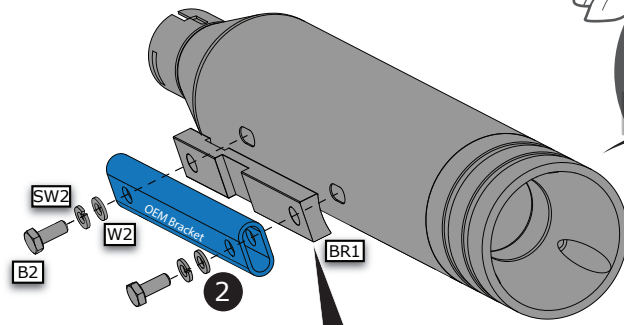

-  **GA** 1x
-  **BR1** 1x
-  **B2** 2x
m8x30
-  **SW2** 2x
-  **W2** 2x

OEM	B2
30Nm 22lbf ft	27Nm 20lbf ft
	
300 km 186 mi	300 km 186 mi
1x 	2x 
3	2

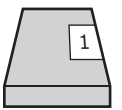
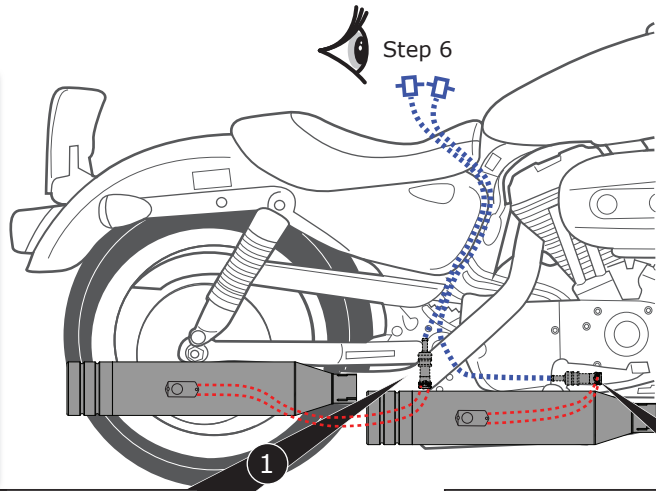
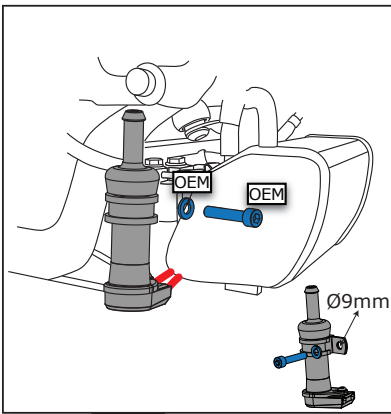

5

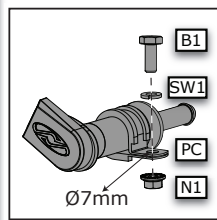
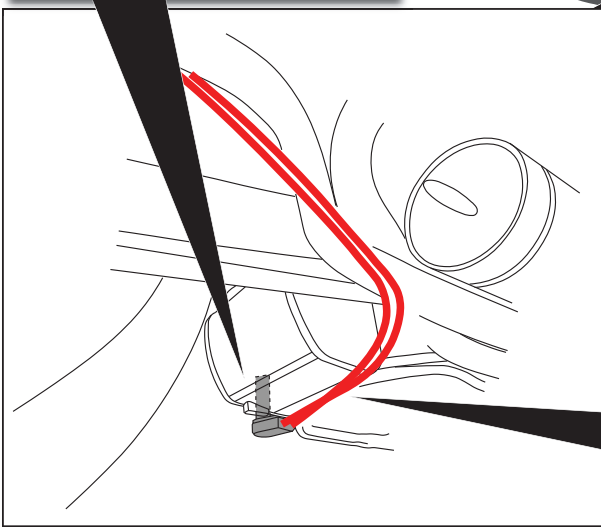

B1
10Nm 7lbf ft

300 km 186 mi
1x 



Use ty-raps to ensure enough ground clearance