



SN.

Dr. Jekyll & Mr. Hyde[®]

THE EXHAUST

MANUAL : HARLEY-DAVIDSON[®] | SMARTBOX 2

NEW IN THIS MANUAL:

- 2021 MODEL
- PLUG & PLAY POWER CABLE



Sport Glide
2021->

1

Sport Glide 2021-> Smartbox 2

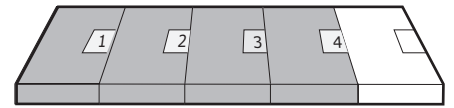

1 Assembly Kit

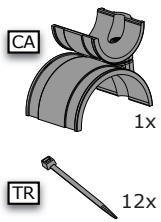

2 Smartbox 2

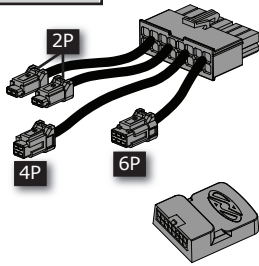

3 Mode Switch for Smartbox

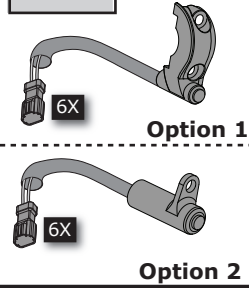

4 Smartbox Power Cable

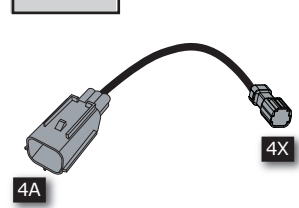

Exhaust/Cable/Servo System

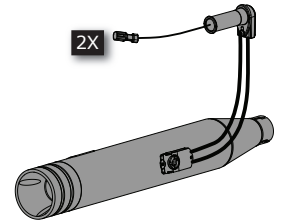

2

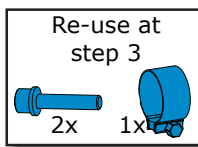
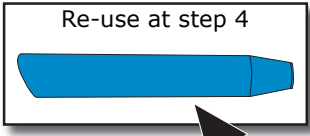
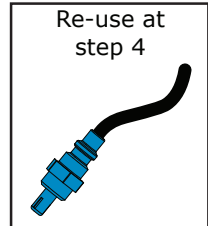
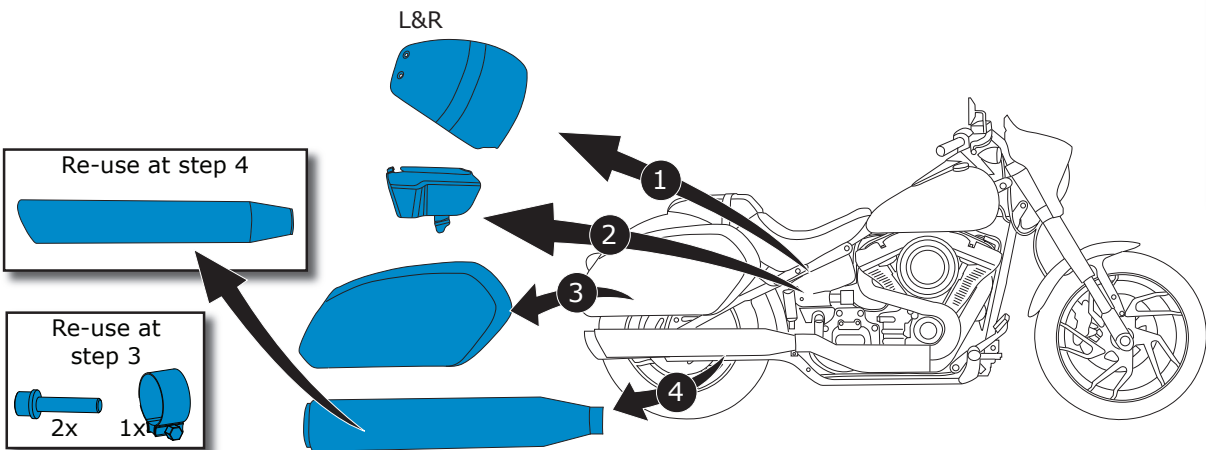

3

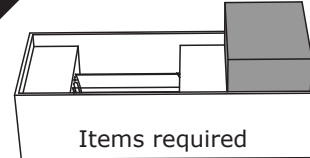

- HD part nr. 65900040
!Always use a NEW Harley-Davidson Gasket!

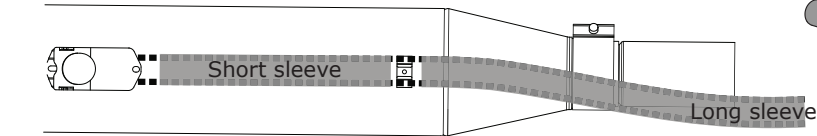
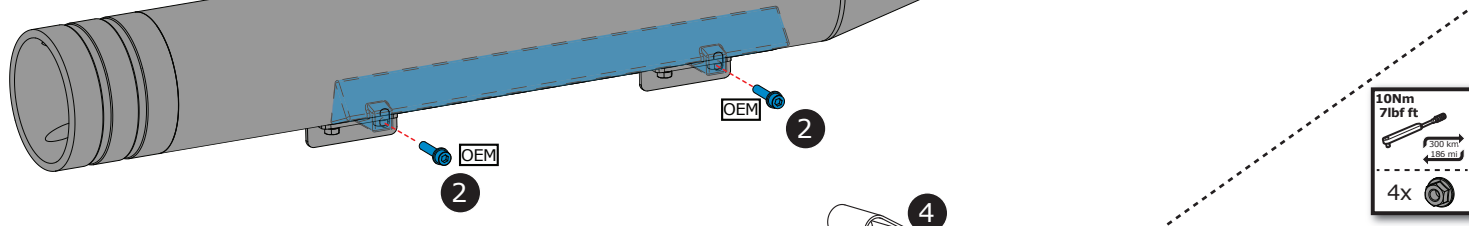
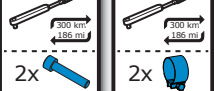
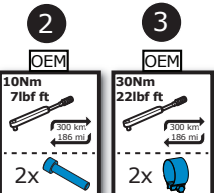

If necessary: Loosen nuts to allign exhaust

4



For safety reasons:
Always reinstall OEM heat shield

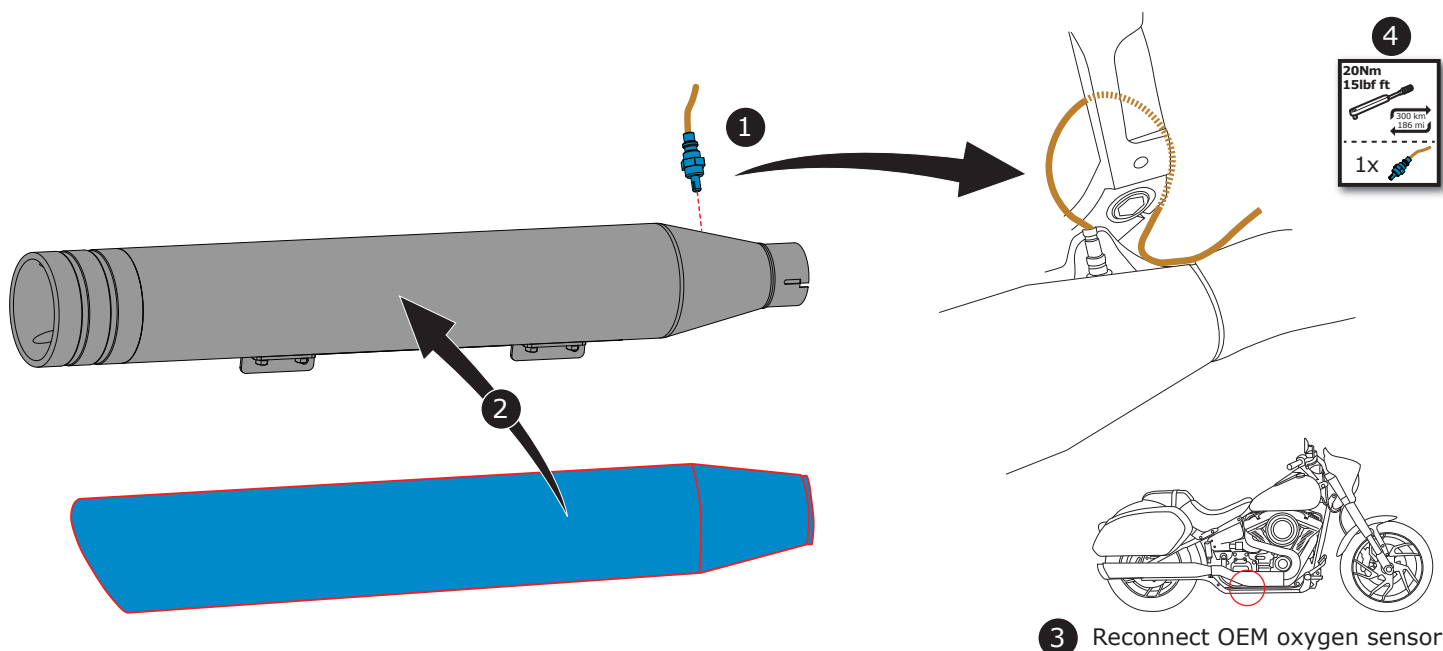

5

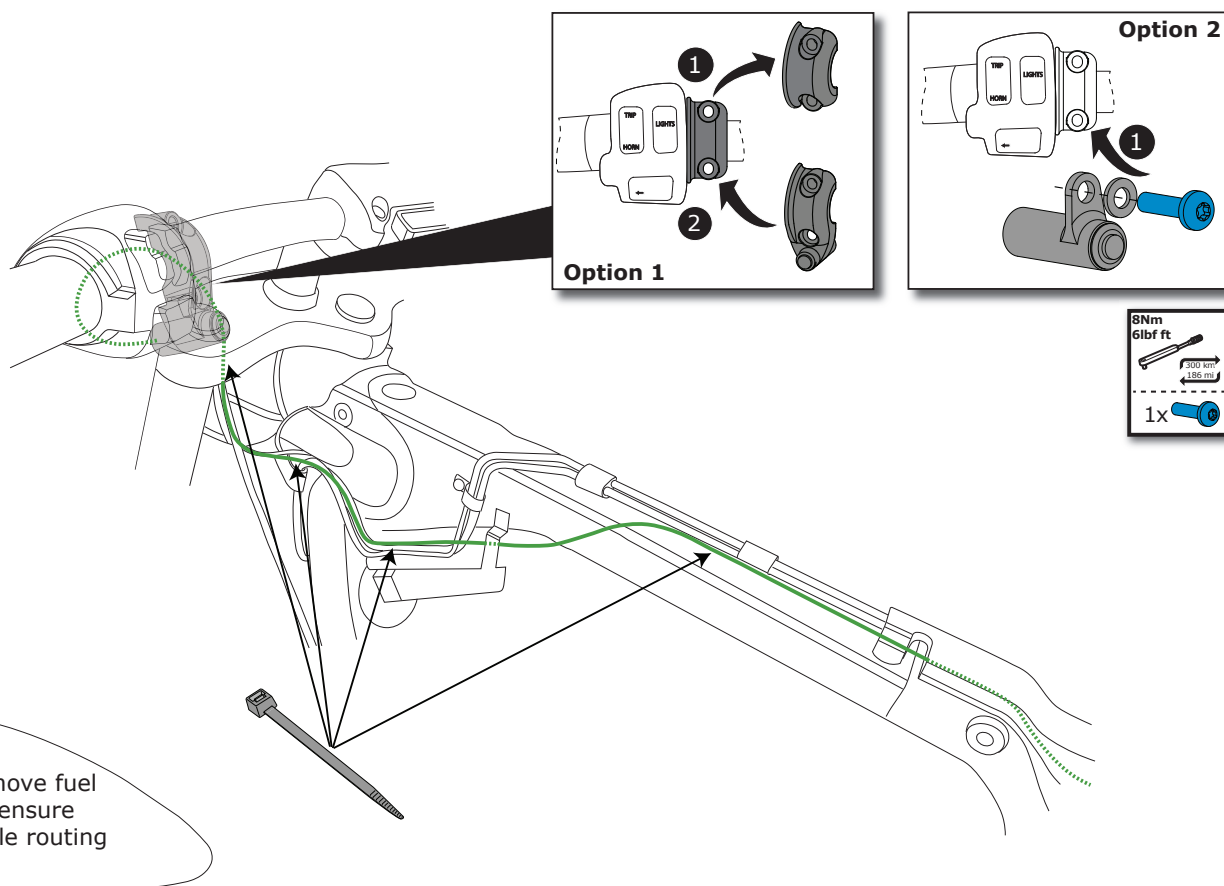
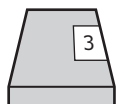

6

Left hand side

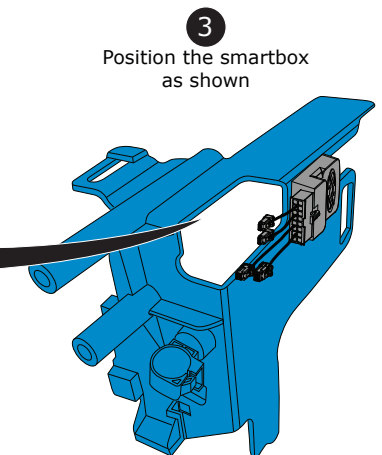
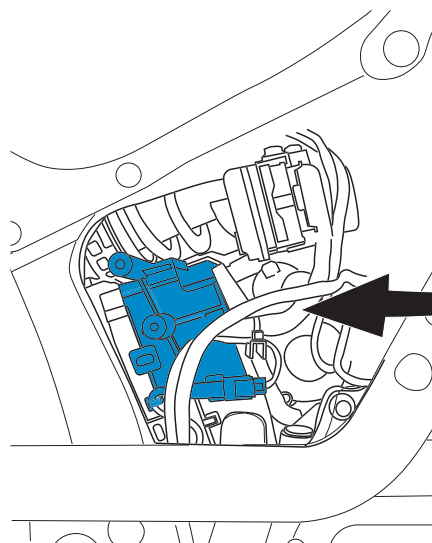
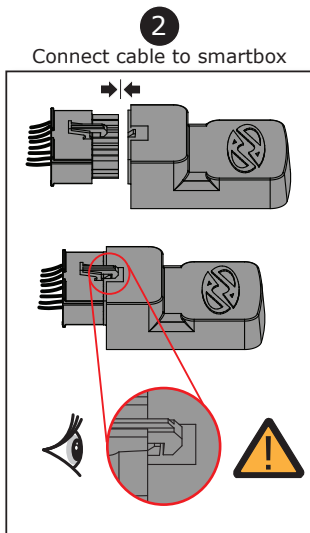
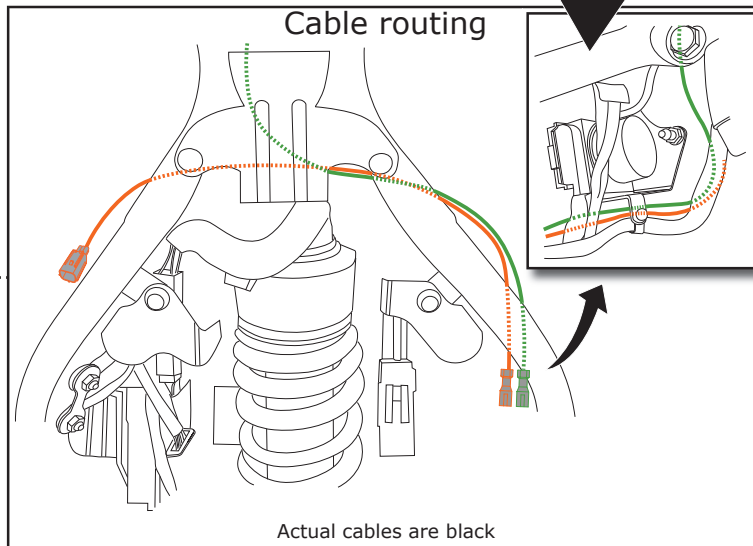
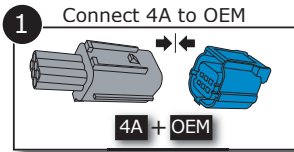
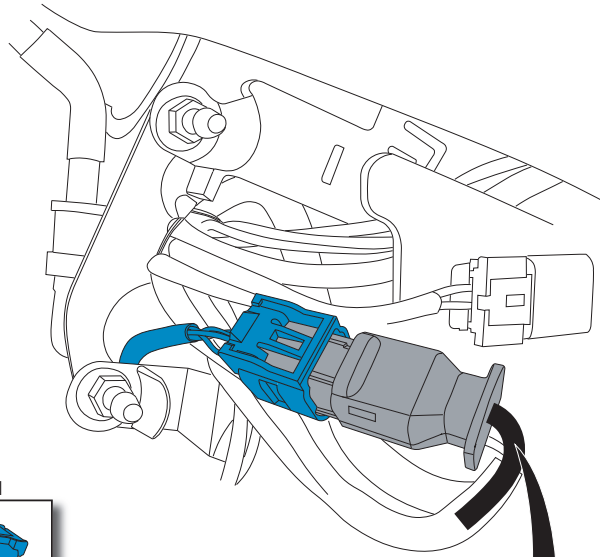
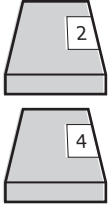

Do not disassemble (image for illustrational purposes)

7

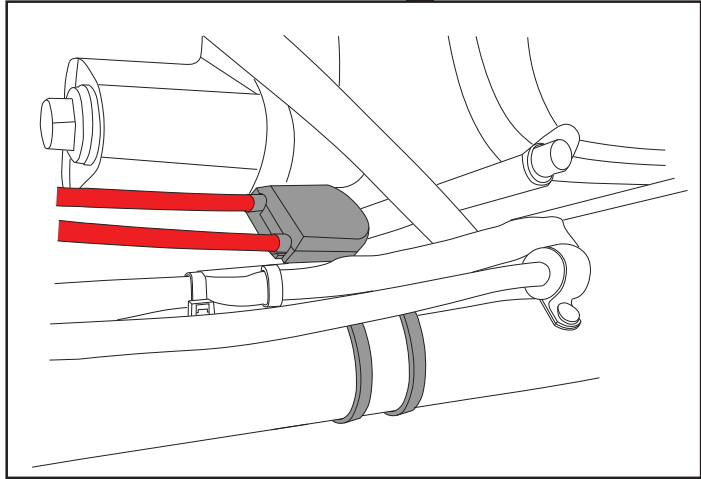
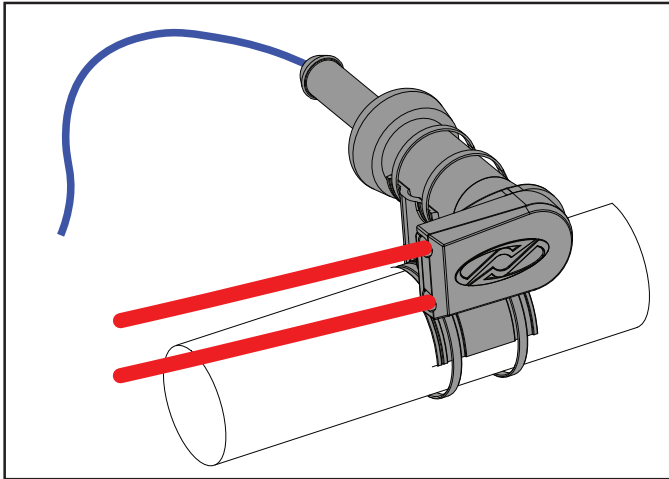
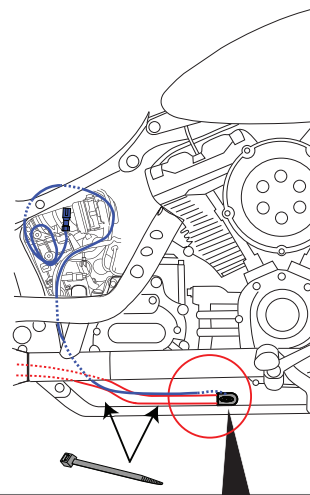
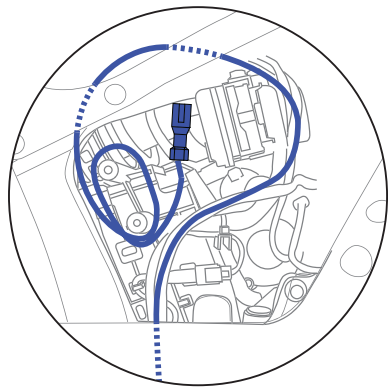
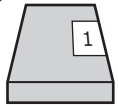

8

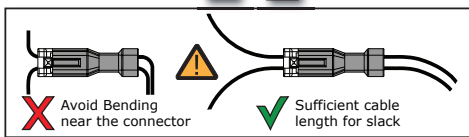
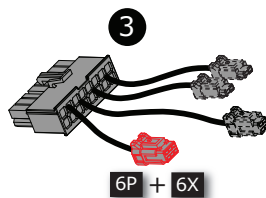
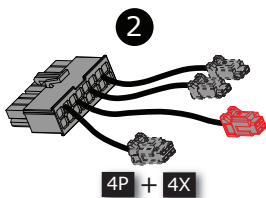
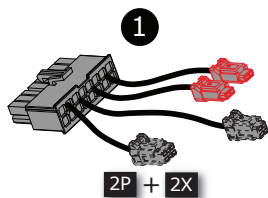

9

Complete System Check!

